



GAMIA METAL

ISTRUZIONI DI POSA

ASSEMBLY INSTRUCTIONS

INSTRUCTIONS DE MONTAGE

INSTRUCCIONES PARA LA COLOCACION

MONTAGEANLEITUNG

Gamia Metal

Descrizione

Scala chiocciola modulare in metallo a pianta circolare, regolabile in altezza tramite distanziatori metallici interposti tra i gradini.

Nr. gradini e altezze raggiungibili per scale "filo-pavimento "

11 + 1 gradini: 2520 - 2760 mm - 12 + 1 gradini: 2730 - 2990 mm - 13 + 1 gradini: 2940 - 3220 mm

Gradini

Di lamiera stampata, con striscia adesive antisdrucciolo

Alzate

Standard Min. 210 mm; Max 230 mm

(per alzate 200 ÷ 210 mm; 230 ÷ 240 mm si possono adattare le colonne in fase di posa).

Ringhiera e altri componenti

A colonne in tubo di metallo Ø 22 mm (luce max tra le colonne < 100 mm).

Corrimano di materiale plastico flessibile (ht. corrimano = 1 m).

Finitura e colori

Parti di metallo: verniciate a forno con polveri epossidiche (Gradini - Grigio chiaro Ral 7035; Colonne - Nero goffrato).
Componenti in plastica, gomma e viteria: nero.

Packing

- a) Confezione nr. 11 gradini semplici completi Ø 1200, 1400, 1600 mm
- b) Confezione pianerottolo di arrivo completo Ø 1250, 1450, 1650 mm
- c) Confezione gradino semplice aggiuntivo Ø 1200, 1400, 1600 mm
- d) Confezione balaustra 1 m e) Confezione "traversino / alzata" per nr. 11 gradini

Description

Modular spiral staircase in metal, with round section and adjustable spacers

Number of steps and „floor-to-floor” height

11+1 steps: 2520-2760 mm (8 3 1/4"-9 0")

12+1 steps: 2730-2990 mm (8 11 1/2"-9 9 3/4")

13+1 steps: 2940-3220 mm (9 7 3/4"-10 6 3/4")

Steps

Of stamped plate, with adhesive non-slippery strips

Risers

Standard Min 210 mm (8 1/4"); Max 230 mm (9") (for risers 200 ÷ 210 mm (7 7/8" ÷ 8 1/4") ; 230 ÷ 240 mm (9" ÷ 9 1/2") it is possible to cut the balusters during the assembly).

Railing

With metal steel tubing balusters Ø 22 mm (7/8") (clear space among the balusters < 100 mm, 4").
Flexible plastic handrail (handrail height = 1000 mm, 39 3/8").

Finishes and colours

Metal : plastic coated (Steps - Light Gray Ral 7035; Balusters - embossed black).

Plastic componentes, rubber matting and screws: black.

Kit

- a) Packing with 11 complete simple steps Ø 1200, 1400, 1600 mm (47 1/4", 55 1/8", 63")
- b) Packing with complete landing platform Ø 1250, 1450, 1650 mm (49 1/4", 57 1/8", 65")
- c) Packing with one simple extra step Ø 1200, 1400, 1600 mm (47 1/4", 55 1/8", 63")
- d) Packing balustrade 1000 mm (39 3/8") long section (handrail apart)
- e) Packing "safety-riser" for 11 steps

Gamia Metal

Description

Escalier hélicoïdal modulaire en métal à plan circulaire réglable en hauteur avec entretoises en métal entre les marches

N. marches et hauteurs possibles au "niveau du sol "

11 + 1 marches: 2520 - 2760 mm - 12 + 1 marches: 2730 - 2990 mm - 13 + 1 marches: 2940 - 3220 mm

Marches

En tôle estampée, avec bandes adhésives antidérapantes

Hauteur de marche

Standard Min. 210 mm ; Max 230 mm (pour hauteurs 200 ÷ 210 mm; 230 ÷ 240 mm balustres adaptables pendant la pose).

Rampe

Avec balustres en tube de métal Ø 22 mm (distance entre les balustres < 100 mm).
Main courante en matériel plastique flexible (hauteur main courante = 1 m).

Finitions et couleurs

Parties en métal: traitées en epoxy (Marches – Gris clair Ral 7035; balustres – noir gaufré).
Parties en plastique, tapis et visserie: noir.

Kit

- a) Carton n. 11 marches simples complètes Ø 1200, 1400, 1600 mm
 - b) Carton palier d'arrivée complet Ø 1250, 1450, 1650 mm
 - c) Carton marche simple supplémentaire Ø 1200, 1400, 1600 mm
 - d) Carton garde-corps 1 m
 - e) Carton " bras / hauteur de marche " pour n. 11 marches
-

Descripción

Escalera de caracol modular de metal con planta circular con altura regulable mediante los distanciadores de metal entre los peldaños.

Nº Peldaños y alturas totales posibles a " nivel del piso "

11 + 1 peldaños: 2520 - 2760 mm
12 + 1 peldaños: 2730 - 2990 mm
13 + 1 peldaños: 2940 - 3220 mm

Peldaños

De chapa estampada, bandas adhesivas antideslizantes

Contrahuellas

Estándar Mín. 210 mm; Max 230 mm (para contrahuellas 200 ÷ 210 mm; 230 ÷ 240 mm los barrotes se pueden adaptar en fase de montaje).

Baranda

De barrotes en tubo de metal Ø 22 mm (luz entre los barrotes < 100 mm).
Pasamanos de material plástico flexible (altura pasamanos = 1 m).

Acabado y colores

Piezas de metal : barnizadas al horno con polvos epoxídicos (peldaños - Gris claro Ral 7035; barrotes negro gofrado).
Elementos de plástico, goma y tornillos : negros.

Kit

- a) Confección 11 peldaños simples Ø1200, 1400, 1600 mm
- b) Confección rellano de desembarque completo Ø 1250, 1450, 1650 mm
- c) Confección peldaño simple extra Ø 1200, 1400, 1600 mm
- d) Confección balaustra 1 m
- e) Confección "barra /contrahuella" para 11 peldaños

Gamia Metal

Beschreibung

Modulare Spindeltrappe aus Metall mit rundem Grundriss regulierbar mit Abstandstücken aus Metall

Anzahl der Stufen und Gesamthöhe der Treppe

11 + 1 Stufen : 2520 - 2760 mm - 12 + 1 Stufen : 2730 - 2990 mm - 13 + 1 Stufen : 2940 - 3220 mm

Stufen

Aus Stanzblech, mit rutschefeste klebestreifen

Setzstufen

Standard Min. 210 mm ; Max 230 mm (für Steigungen $200 \div 210$ mm; $230 \div 240$ mm verstellbar während der Montage).

Geländer

Mit Metallstäben $\varnothing 22$ mm (Distanz zwischen der Stäben max < 100 mm).
Modulierbarer Handlauf aus Plastik (Höhe Handlauf = 1 m).

Oberflächenausführung und Farben

Metallteile: Epoxyd Einbrennlackierung (Stufen - Hellgrau Ral 7035; Stäbe - schwarz gaufriert).
Elemente aus Plastik, Auflagen und Schrauben: schwarz.

Kit

- a) Verpackungseinheit mit 11 kompletten Stufen $\varnothing 1200, 1400, 1600$ mm
- b) Verpackungseinheit mit komplettem Podest $\varnothing 1250, 1450, 1650$ mm
- c) Verpackungseinheit mit zusätzlicher Stufe $\varnothing 1200, 1400, 1600$ mm
- d) Verpackungseinheit Balustrade 1000 mm
- e) Verpackungseinheit „Sicherheit der Steigung“ für 11 Stufen (Kinder-Sicherung)

Gamia Metal

Verificare le dimensioni del vano scala prima di procedere con la posa. Controllare che, nelle zone dove verranno effettuati i fissaggi della scala, non vi siano tubature o cavi elettrici, onde evitarne il danneggiamento.

After assemble the stair, check well all staircase well dimension. Before starting to install the stair, make sure that in the installation area there are no pipes or power cables to prevent damaging these.

Vérifier les dimensions de la cage avant de procéder à la pose. Vérifier que les fixations de l'escalier ne tombent pas sur des conduites ou des câbles électriques

Verificar las dimensiones del espacio donde irá la escalera antes de iniciar el montaje Controlar que, en las zonas donde se efectuarán las fijaciones de la escalera, no haya tubos o cables eléctricos, para evitar daños.

Vor Beginn der Treppemontage messen Sie das Treppenhaus nach. Um Beschädigungen zu vermeiden, überprüfen Sie vor Beginn der Montage, daß sich in dem Bereich, in dem die Treppe befestigt wird, keine Rohrleitungen oder elektrische Kabel befinden.

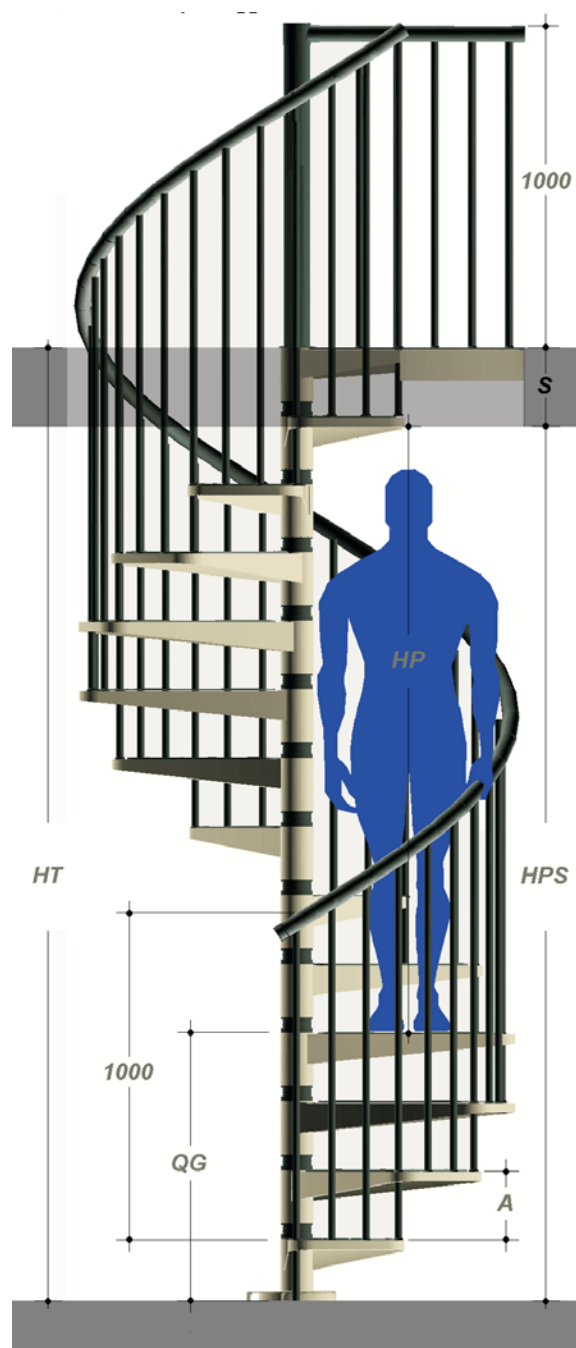

HT - Altezza totale da pavimento a pavimento (HPS+S)
HPS - Altezza da pavimento inferiore a soffitto (HT-S)
S - Spessore solaio (HT-HPS)
A - Altezza alzata (HT/Nr. alzate)

HT - Hauteur totale sol fini à sol fini (HPS+S)
HPS - Hauteur sous plafond (HT-S)
S - Epaisseur de la dalle (HT-HPS)
A - Hauteur de la marche (Hauteur totale : n.hauteurs de marches)

HT - Altura total de suelo a suelo (HPS+S)
HPS - Altura de suelo inferior a techo (HT-S)
S - Espesor de la losa o piso (HT-HPS)
A - Altura contrahuella (HT / Nr. contrahuellas)

HT - Floor-to-floor height (HPS+S)
HPS - Floor-to-ceiling height (HT-S)
S - Floor thickness (HT-HPS)
A - Riser height (HT : riser number)

HT - Höhe Oberkante Fertigfußboden / Oberkante Fertigfußboden (HPS+S) "93Stockwerkshöhe"93
HPS - Höhe Oberkante Fertigfußboden / Decke (HT-S)
S - Deckenstärke (HT-HPS)
A - Steigung (HT : Anzahl der Steigungen)

Gamia Metal

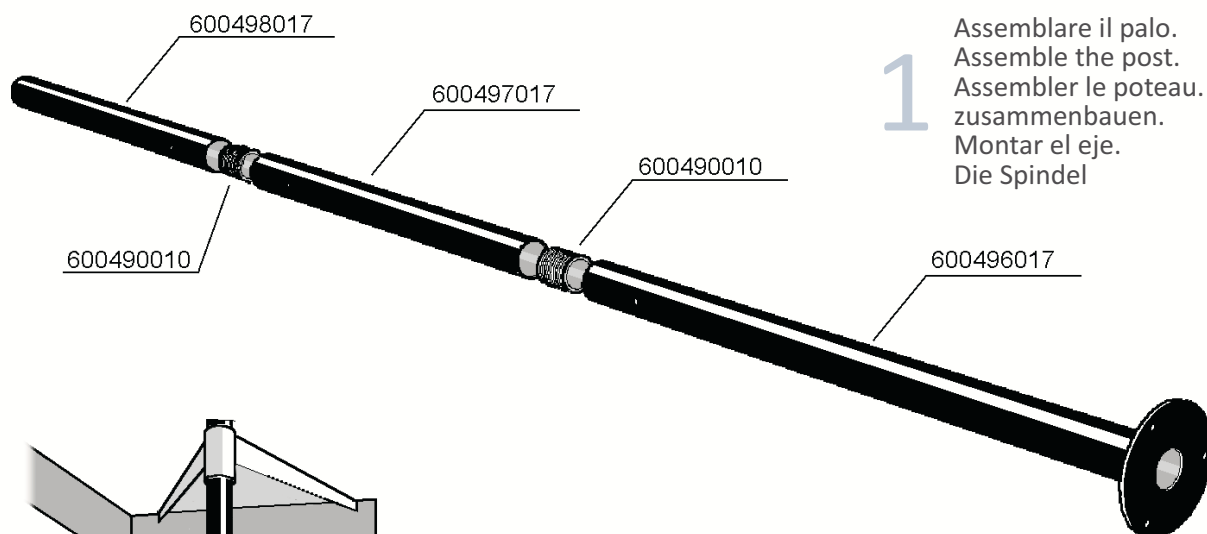

1

Assemblare il palo.
Assemble the post.
Assembler le poteau.
zusammenbauen.
Montar el eje.
Die Spindel

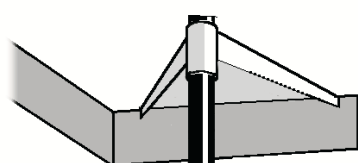

Posizionare il palo in riferimento al foro, disponendo il gradino di arrivo sul lato di uscita della scala.

Position the post with reference to the opening, arranging the landing step on the exit side of the stair

2

Positionner le poteau dans l'axe exact de la trémie, en plaçant la marche d'arrivée sur le côté de sortie de l'escalier.

Colocar el eje con referencia al orificio, poniendo el rellano de desembarque sobre el lado de salida de la escalera.

Die Spindel vollkommen ausrichten und dabei das Austrittspodest als Anhaltspunkt benutzen.

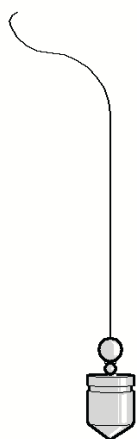

630333042

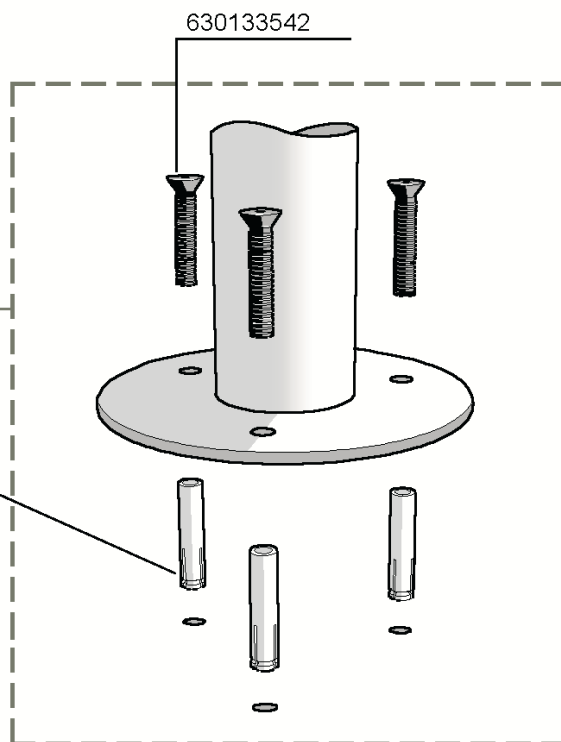

Gamia Metal

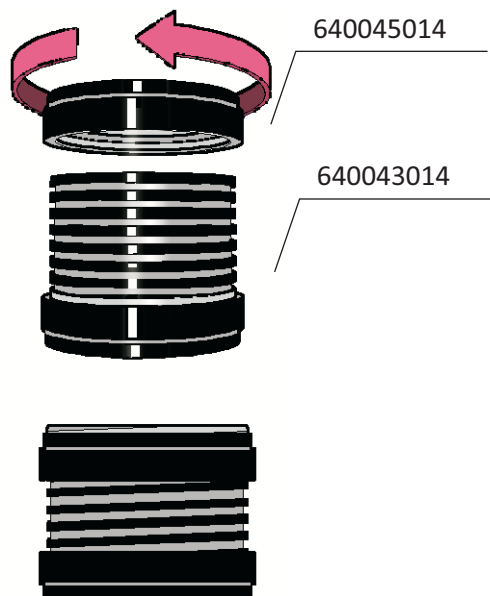

Alzata 170 mm
Riser-170 mm (6 11/16")
Hauteur de marche - 170 mm
Contrahuella 170 mm
Steigung - 170 mm

Regolare i distanziali in plastica avvitando la ghiera filettata, lasciando tra le due battute una distanza pari a "Alzata - 170 mm".

Regulate the plastic spacers adjusting the ring nut, leaving between the two ledges a distance equivalent to:
Riser - 170 mm (6 11/16").

3

Régler les entretoises en plastique en serrant la bague filetée et en gardant une distance égale à "Hauteur de marche - 170 mm".

Regular los distanciadores de plástico enroscando la virola roscada, dejando entre los dos topes una distancia equivalente a "Contrahuella - 170 mm".

Die Distanzstücke zusammenbauen und den Gewindeflansch auf die erforderlich Auftrittshöhe einstellen und lassen Sie zwischen eine Höhe von „Steigung - 170 mm“ feststellen.

Inserire gli elementi nel palo iniziando dal copripiastra in basso, proseguendo con distanziali e gradini, sino all'inserimento del gradino di arrivo.

Insert the elements in the post beginning from the plate cover, going on with spacers and steps and finishing with the landing.

4

Empiler tour à tour les éléments (entretoises et marches) dans le poteau sans oublier au départ le couvreembase et terminer avec l'installation de la marche d'arrivée.

Insertar los elementos en el eje comenzando por la brida del eje, continuando con los distanciadores y los peldaños, hasta insertar el rellano de desembarque.

Alle Elemente in die Spindel einsetzen:
Plattenabdeckung, Distanzstücken, Stufen und Austrittsstufe.

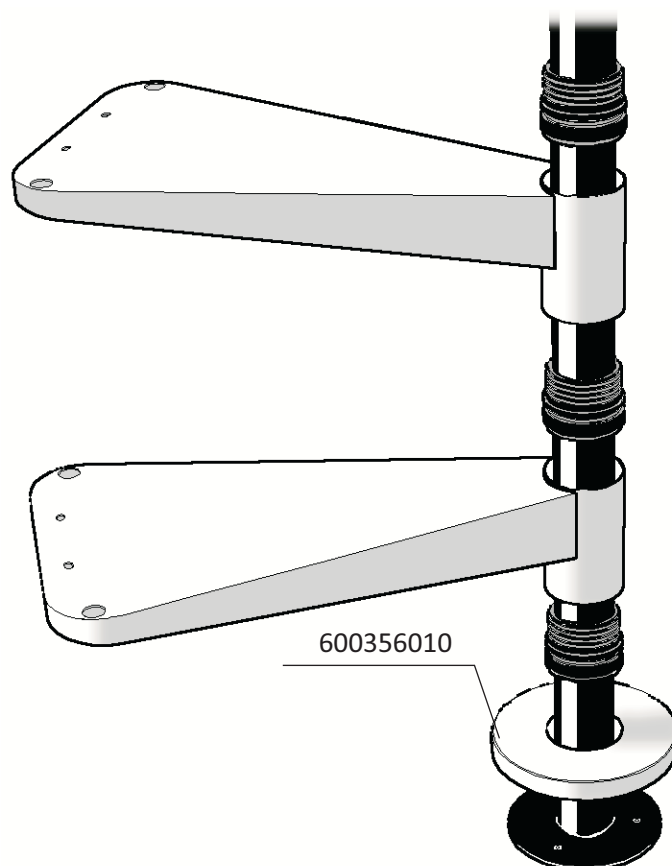

Gamia Metal

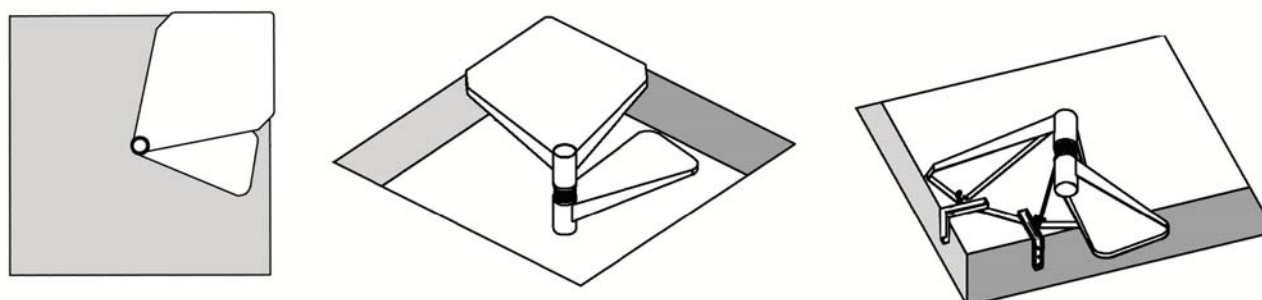
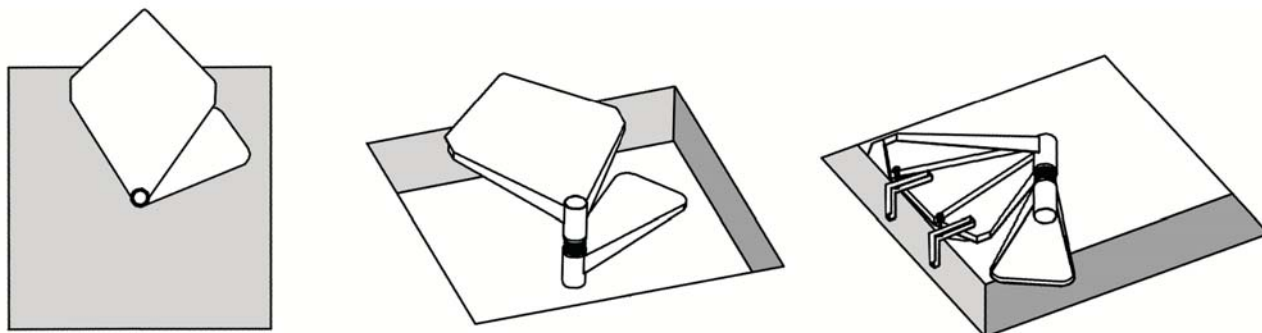
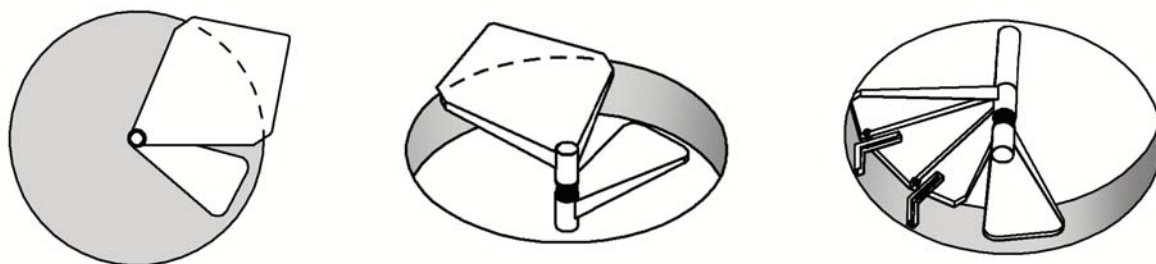

5

- Fissare pianerottolo di arrivo.
- Position the landing.
- Positionner la marche d'arrivée.
- Fijar el rellano de desembarque
- Das Podest befestigen.

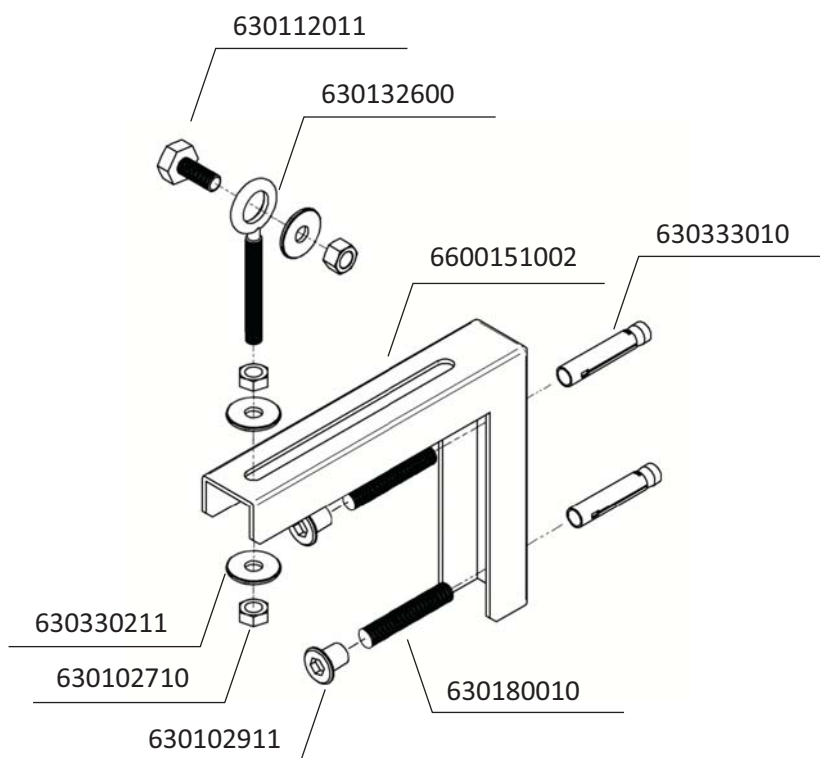

Gamia Metal

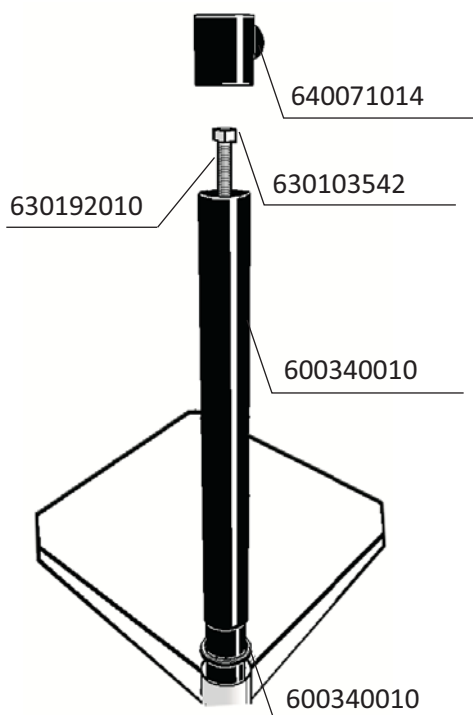

6 Inserire nel palo la flangia terminale.
Insert in the post the upper post washer.
Insérer dans le poteau le bride terminal.
Insertar en el eje la brida terminal.
Den Abschlussflansch einsetzen.

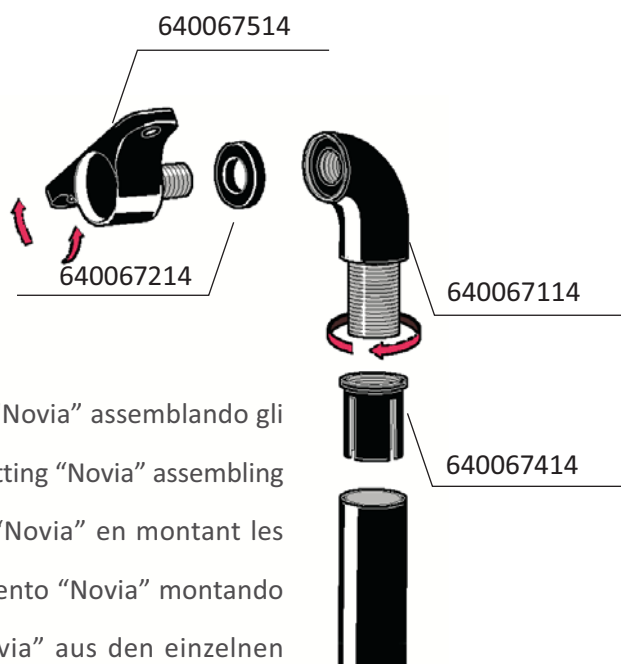

7 Comporre il raccordo "Novia" assemblando gli elementi.
Put together the pipe fitting "Novia" assembling the elements.
Assembler le raccord "Novia" en montant les éléments.
Componer el acoplamiento "Novia" montando los elementos.
Das Anschlußstück "Novia" aus den einzelnen Elementen zusammenbauen.

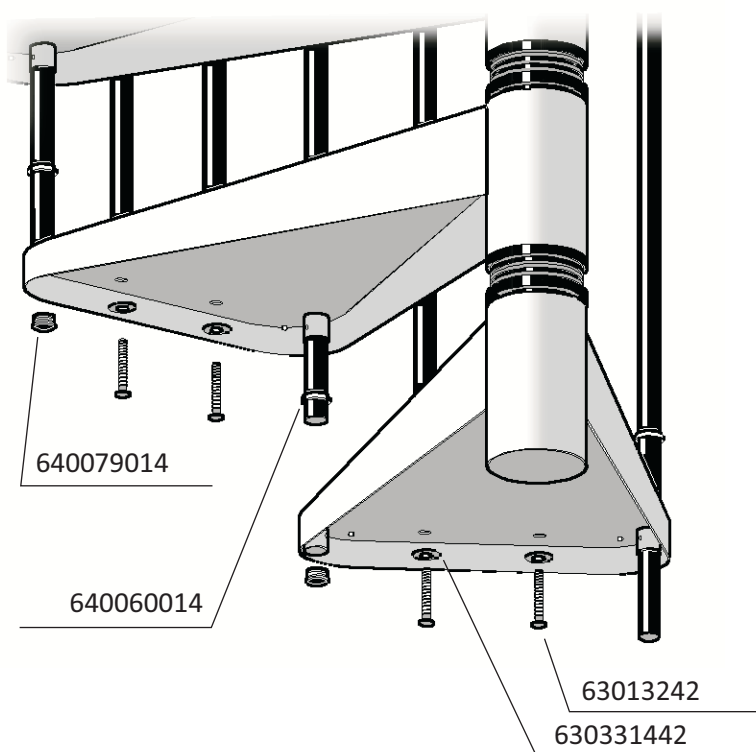

Inserire le colonne in tutti i gradini, bloccando quelle passanti con i grani e quelle sul gradino con la boccola ad espansione "Espa".

Insert balusters in all steps, doweling the ones that go through the step and locking the other ones with the expansion bushing "Espa".

Insérer les balustres dans toutes les marches en bloquant ceux du type passant avec les vis et ceux sur la marche avec l'expansion "Espa".

Insertar los barrotes en todos los peldaños, bloqueando aquellos pasantes con los tornillos sin cabeza y aquellos sobre el peldaño con el casquillo de expansión "Espa".

Die durchführenden Stäbe müssen durch die Stifte befestigt werden.
Die andere Stäbe in allen Stufen mit den Expansions buchsen „Espa“ einsetzen.

Gamia Metal

La prima colonna della scala va tagliata e fissata a terra tramite il "Bicchierino".

The first baluster of the stair need to be cut and secured to the floor with pipe fitting „Bicchierino”.

9 Découper et fixer au sol le premier balustre avec le gobelet "Bicchierino".

El primer barrote de la escalera se corta y se fija en el suelo mediante la taza "Bicchierino".

Das erste Stab der Treppe wird geschnitten und mit dem "Bicchierino" befestigt.

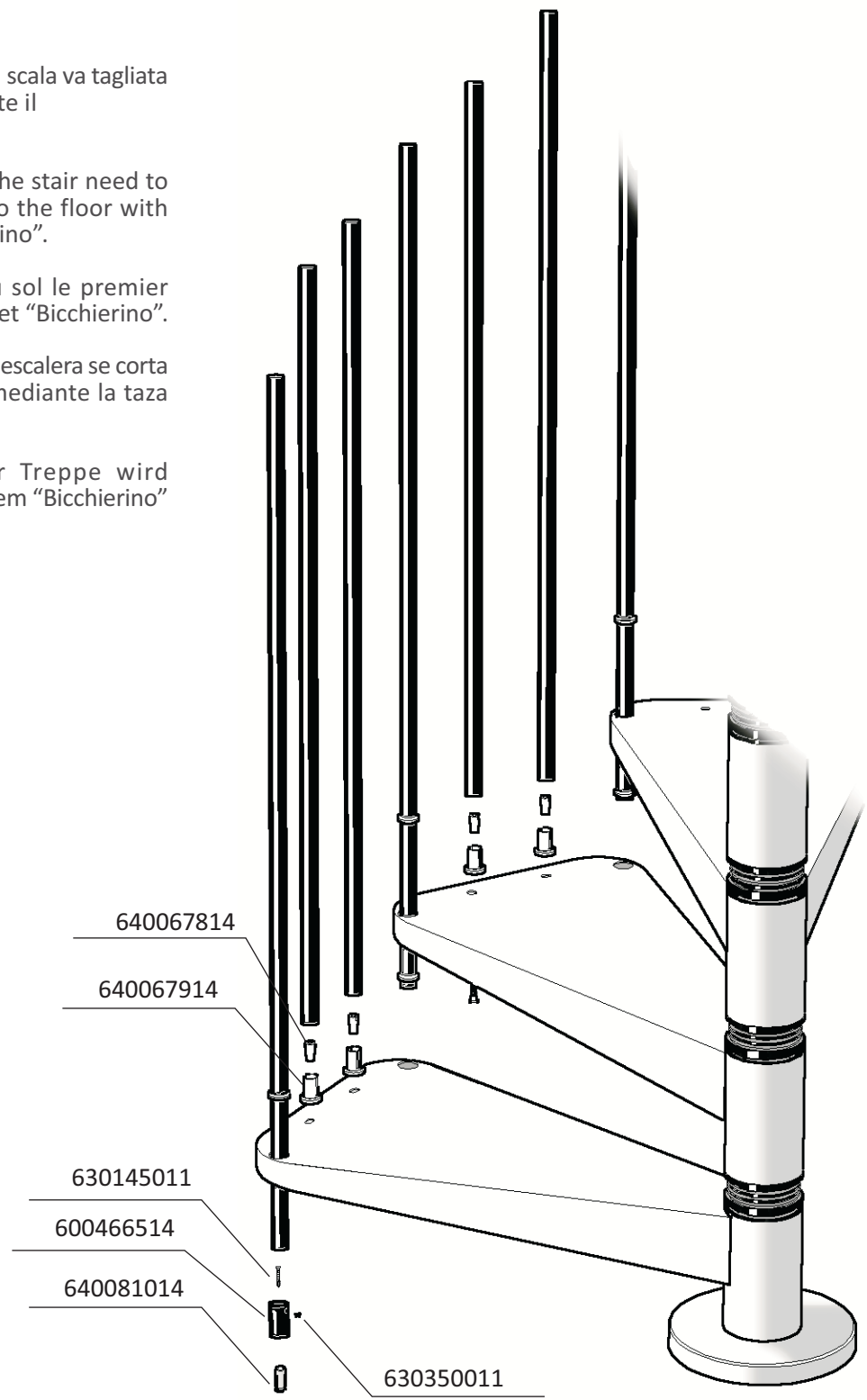

Gamia Metal

10

Regolazione colonne

Prima di bloccare le colonne eseguire la regolazione della pendenza in funzione dell'alzata.

Balusters ajustement

Before baluster's tightening it is necessary to adjust the slope according to the risers.

Réglage des balustres

Avant de bloquer les balustres, régler les en fonction de la pente créée par la hauteur de marche.

Regulación de los barrotes

Antes de bloquear los barrotes, hay que regular la pendencia en función de la contrahuella.

Einstellung der Stäbe

Vor der Befestigung der Stäbe muß die Steigung in Abhängigkeit von der Stufenhöhe eingestellt werden.

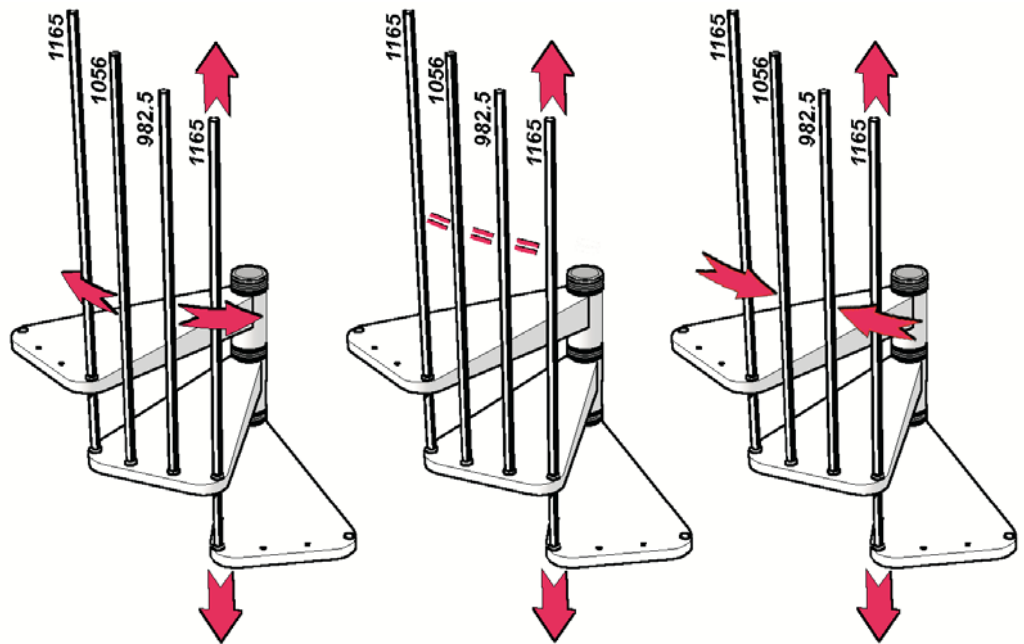

Ø scala / stair/ escalier / escalera/ treppe
120 – 140 mm; (47 1/4" - 55 1/8");

Ø scala / stair/ escalier / escalera/ treppe
160 mm (63")

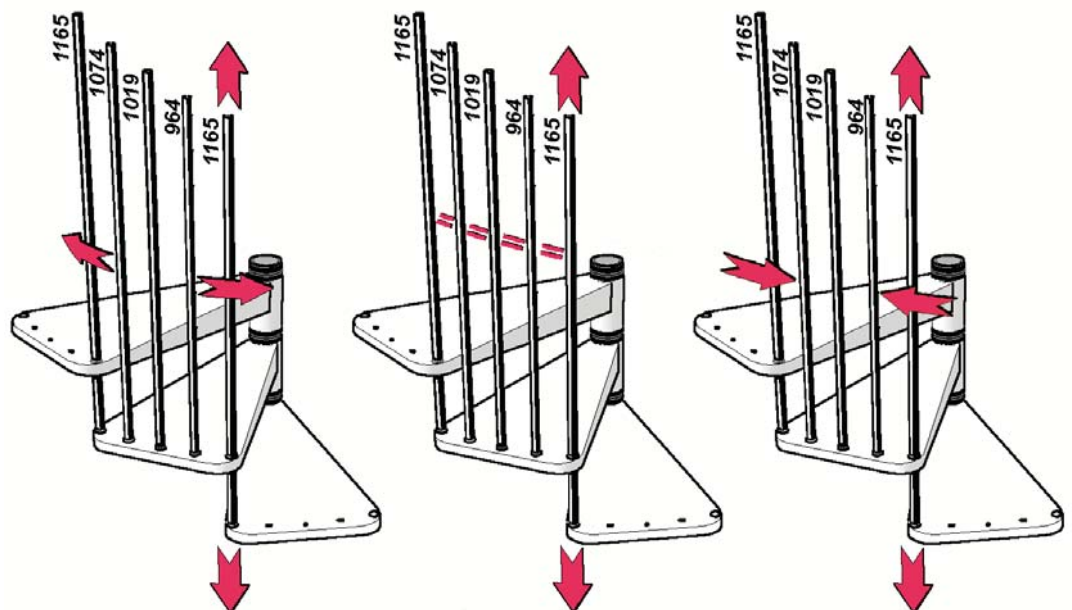

Gamia Metal



11

Questo disegno mostra il kit "traversino / alzata" montato sul mod. GAMIA LEGNO. Per la scala GAMIA METALLO le istruzioni di montaggio sono le medesime.

This draw shows the assembling of "Safety-riser" for model Gamia Wood. The same instructions are for model Gamia Metal.

Ce dessin montre le kit bras / hauteur de marche assemblé sur le modèle GAMIA BOIS. Pour l'escalier GAMIA METAL les instructions de montage sont les mêmes.

Este diseño muestra el kit barra/contrahuella montado sobre el modelo GAMIA MADERA. Para la escalera GAMIA METAL las instrucciones de montaje son las mismas.

Die Zeichnung betrifft die Kit "Sicherheit der Steigung" für das Modell Gamia Holz Was die Gamia Metall betrifft so ist die Montageanleitung die gleiche.

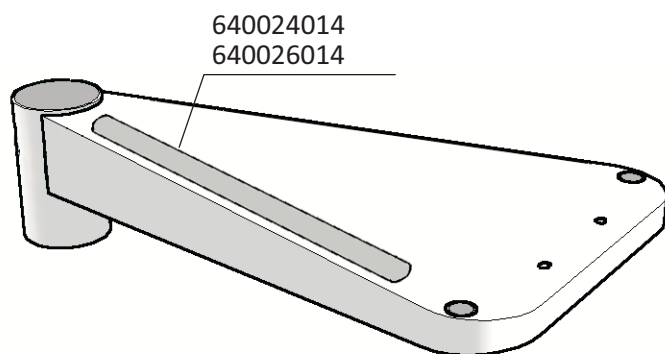

12

Completato il montaggio della scala, applicare su tutti i gradini le strisce adesive antiscivolo
Having completed the staircase assembly, apply the supplied adhesive non-slippery strips
Une fois le montage de l'escalier terminé, appliquer sur toutes les marches bandes adhésives antidérapantes
Fertig gestellt Montage der Treppe, gelten für sämtliche Stufen der rutschfeste Klebestreifen.
Completando el montaje de la escalera utilizar las bandas adhesivas antideslizantes

Gamia Metal

13

Montaggio balaustrino del gradino di arrivo
Forare il gradino di arrivo con punta \varnothing 10 mm utilizzando la sagoma di cartone in dotazione.

Montage de la rampe du palier d'arrivée
Percer la marche d'arrivée avec un foret \varnothing 10 mm en utilisant le gabarit en carton fourni.

Montaje de la barandilla del rellano de desembarque
Perforar el rellano de desembarque con una punta \varnothing 10 mm utilizando la plantilla que viene en el paquete.

Assembling of landing balustrade
Drill holes in the landing step with a \varnothing 10 mm (3/8") bit, using the issued paper template.

Montage des Geländerpodest
Die Austrittstufe mit einem Bohrer \varnothing 10 mm bohren und dabei die migelieferte Schablone verwenden.

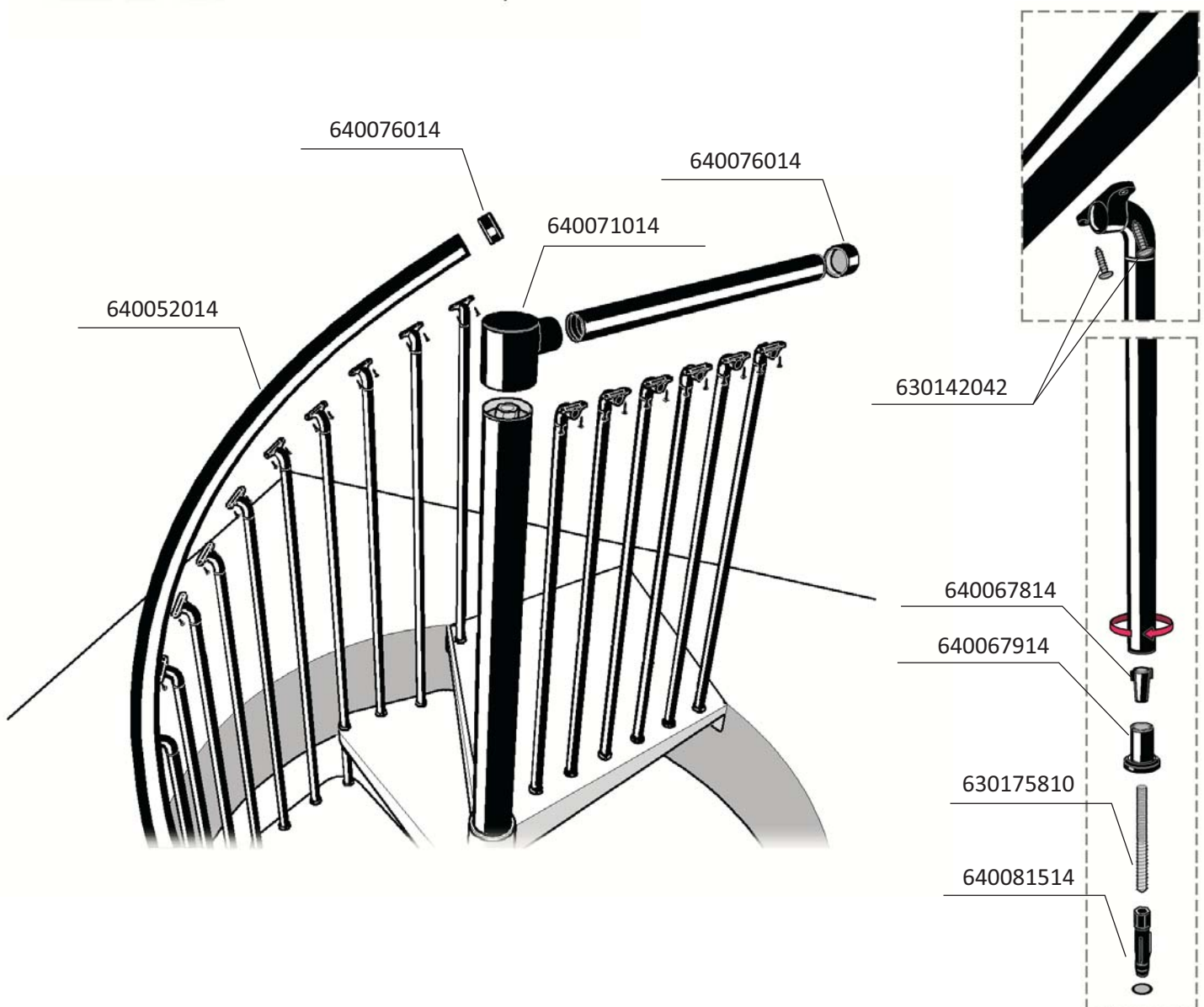
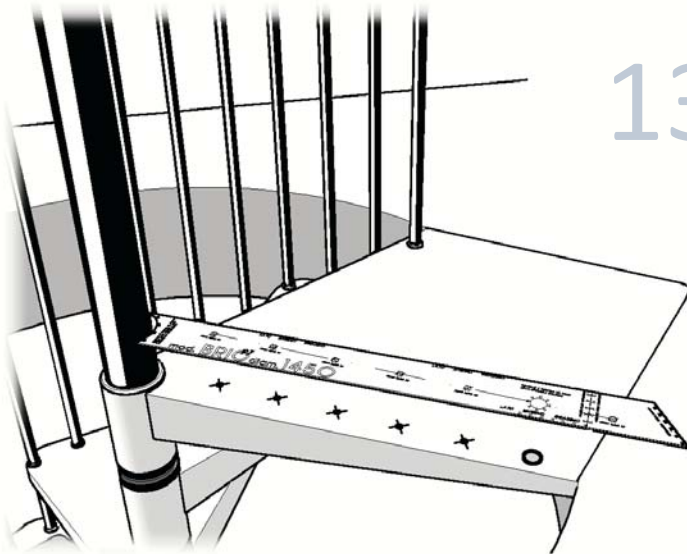

Gamia Metal

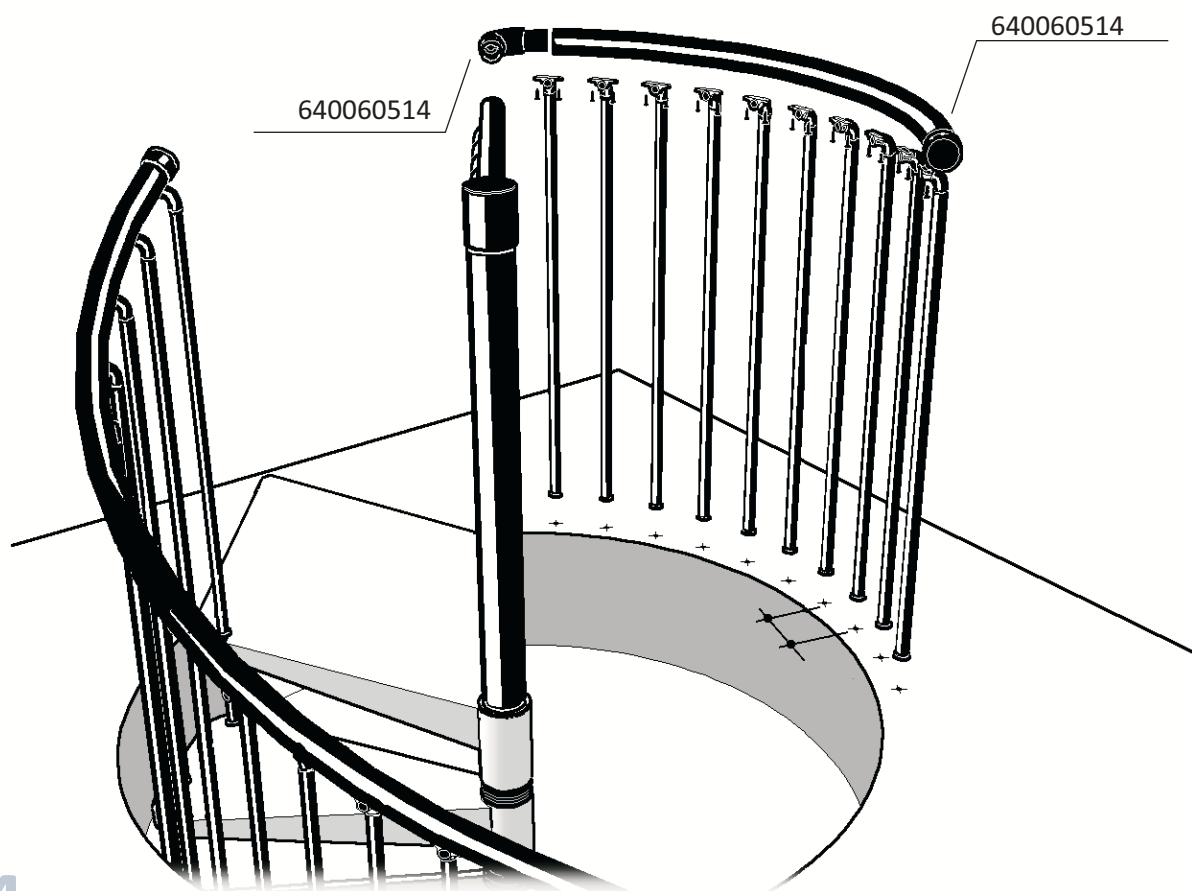

14

Montaggio Balastra

-Assemblare le colonne (ht. 925 mm) inserendo la boccola "Espa" ed avvitando il mordente. -Tracciare sul pavimento il centro delle colonne mantenendo la distanza dal foro di circa 50 mm (L'interasse tra le colonne non deve superare i 120 mm). - Forare con punta \varnothing 12 mm ed inserire gli espansori in nylon.

Balusters assembling

- Assemble the balusters (Ht. 925 mm, 36 3/8") connecting the bushing "Espa" and screwing the fitting. - Mark out the floor the central position of the balusters for the balustrade, note also that a distance of about 50 mm (2") from the opening is needed and that the axle base among the balusters can't be over 120 mm (4 1/2"). - Drill holes with a \varnothing 12 mm (1/2"94) bit and insert the nylon expanders.

Montage du garde-corps









-Assembler les balustres du garde-corps (h. 925 mm) en insérant la pièce "Espa" et en serrant le mordant. -Tracer au sol l'axe des balustres du garde corps en gardant une distance par rapport au bord de la trémie d'environ 50 mm (L'entraxe entre les balustres ne doit pas excéder les 120 mm). - Percer avec un foret \varnothing 12 mm et insérer les chevilles à expansion en nylon.

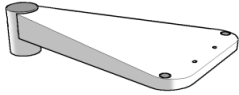
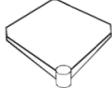
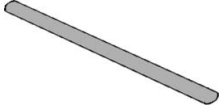
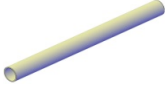
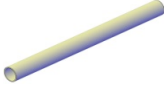
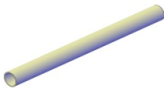
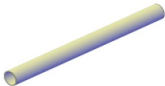
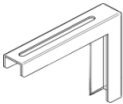















Montaje balastra













-Montar los barrotes (ht. tot. 925 mm) metiendo el casquillo de expansión "Espa" y atornillando el mordente. -Señalar sobre el suelo el centro de los barrotes manteniendo la distancia desde el orificio de alrededor de 50 mm (la distancia entre los agujeros de los barrotes no tiene que superar los 120 mm). - Perforar con una punta \varnothing 12 mm e introducir los expansores de nylon.

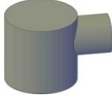



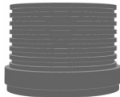



Montage der Balustrade

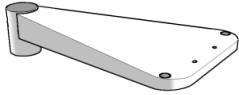
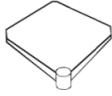
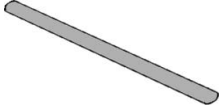
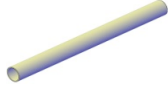
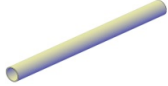
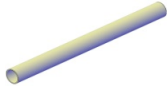
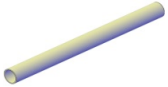
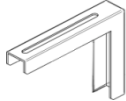













- Die Stäbe der Balustrade (H 925 mm) zusammenbauen, in dem die „Espa“ - Buchsen eingesetzt werden; dann die selbstschneidende Schraube anziehen, bis sie greift - Auf dem Boden die Mitte der Stäbe für die Balustrade anzeichnen und dabei berücksichtigen, dass ein Abstand von der Öffnung von ca.50 mm eingehalten werden muss und dass der Abstand zwischen der Stäben nicht mehr als 120 mm betragen darf. - Dann die Löcher mit einem Bohrer \varnothing 12 mm bohren und die Expansionselemente aus Nylon einsetzen: an diesem Punkt die Stäbe anschrauben und den Handlauf befestigen.

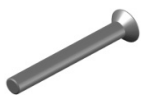













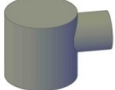

Ø 1200	KIT 12+1	COD.	IMAGE
	12	600042002	
	1	600100202	
	13	640024014	
	5	600230514	
	12	600231714	
	12	600232514	
	14	600233014	
	2	600151002	
	1	600343002	
	1	600356002	
	2	600490000	
	1	600496002	
	1	600497002	
	1	600498002	
	1	600340002	
	1	600467514	









Ø 1200	KIT 12+1	COD.	IMAGE
	2	600466514	
	1	630103510	
	6	630102710	
	88	630142011	
	2	630145011	
	4	630180010	
	2	630132600	
	3	630133511	
	30	630132011	
	2	630112011	
	1	630192000	
	42	630350011	
	7	630333010	
	4	630102911	
	30	630331411	
	6	630330211	

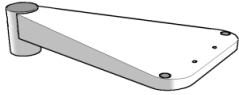
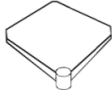
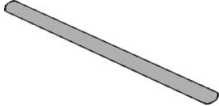
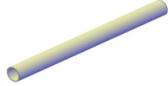
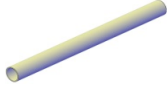
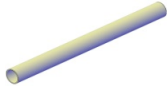
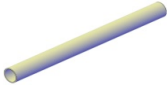
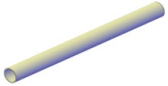
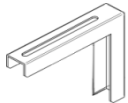















Ø 1200	KIT 12+1	COD.	IMAGE
	1	9964520	
	44	640067114	
	44	640067214	
	44	640067414	
	44	640067514	
	1	640071014	
	3	640076014	
	12	640079014	
	1	650800000	
	13	640043014	
	13	640045014	
	30	640067814	
	30	640067914	
	2	640081014	
	27	640060014	













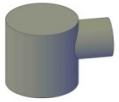

Ø 1400	KIT 12+1	COD.	IMAGE
	12	600044002	
	1	600100402	
	13	640026014	
	5	600230514	
	12	600231714	
	12	600232514	
	14	600233014	
	2	600151002	
	1	600343002	
	1	600356002	
	2	600490000	
	1	600496002	
	1	600497002	
	1	600498002	
	1	600340002	
	1	600467514	

Ø 1400	KIT 12+1	COD.	IMAGE
	2	600466514	
	1	630103510	
	6	630102710	
	88	630142011	
	2	630145011	
	4	630180010	
	2	630132600	
	3	630133511	
	30	630132011	
	2	630112011	
	1	630192000	
	42	630350011	
	7	630333010	
	4	630102911	
	30	630331411	
	6	630330211	

Ø 1400	KIT 12+1	COD.	IMAGE
	-	9964520	
	1	9964525	
	44	640067114	
	44	640067214	
	44	640067414	
	44	640067514	
	1	640071014	
	3	640076014	
	11	640079014	
	1	650800000	
	13	640043014	
	13	640045014	
	30	640067814	
	30	640067914	
	2	640081014	
	27	640060014	

Ø 1600	Q. KIT 12+1	COD.	IMAGE
	12	600044002	
	1	600100402	
	13	640026014	
	6	600230514	
	12	600231714	
	12	600232514	
	12	600232714	
	14	600233014	
	2	600151002	
	1	600343002	
	1	600356002	
	2	600490000	
	1	600496002	
	1	600497002	
	1	600498002	
	1	600340002	

Ø 1600	Q. KIT 12+1	COD.	IMAGE
	2	600467514	
	3	600466514	
	1	630103510	
	6	630102710	
	114	630142011	
	3	630145011	
	4	630180010	
	2	630132600	
	3	630133511	
	43	630132011	
	2	630112011	
	1	630192000	
	43	630350011	
	7	630333010	
	4	630102911	
	43	630331411	

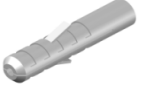
Ø 1600	Q. KIT 12+1	COD.	IMAGE
	6	630330211	
	1	9964525	
	57	640067114	
	57	640067214	
	57	640067414	
	57	640067514	
	1	640071014	
	3	640076014	
	12	640079014	
	1	650800000	
	13	640043014	
	13	640045014	
	43	640067814	
	43	640067914	
	3	640081014	
	26	640060014	